

MODEL NO. 1018S HEAVY-DUTY STRAIGHT STUDIO TRACK

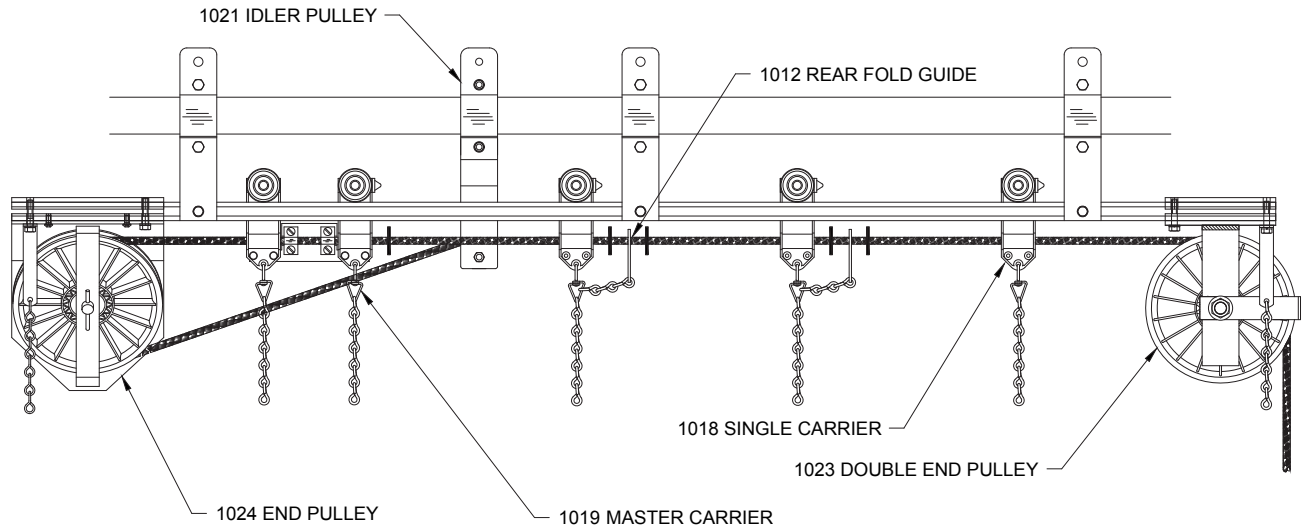

Model No. 1018S Heavy-Duty Straight Track was developed especially for use in television studios where an exceptionally quiet, heavy-duty track is desired. Equipped with urethane-tired shielded ball bearing wheels and neoprene bumpers to insure the quietest operation available in a stage track. Track furnished with rear fold guides which enable curtain to fold at offstage edges during operation. Track sections available in 10 and 20 foot standard lengths.



No. 1018 BLACK SINGLE CARRIER

2 urethane-tired shielded ball bearing wheels riveted to black Nylatron GS body with heavy-duty hook, swivel and 6" trim chain for curtain attachment. Supplied with 1 rubber bumper.

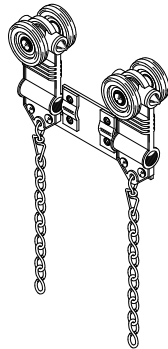

No. 1019 BLACK MASTER CARRIER

2 No. 1018 single carriers riveted to steel body. 2 clamps provided for anchoring line or cable. Supplied with 1 rubber bumper. 1 pair required for overlapping tracks.

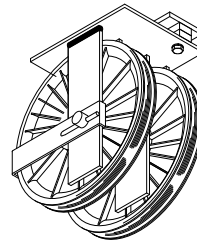

No. 1023 8" BLACK DOUBLE END PULLEY

8" diameter Nylatron GS sheaves with precision sealed ball bearings. Heavy-duty steel housing clamps to underside of track. Chain bracket for securing offstage curtain edge. Grooved for 1/2" operating line.

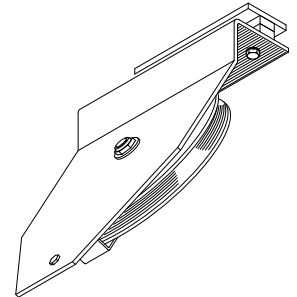

No. 1024 BLACK 8" SLANTED SINGLE END PULLEY

8" diameter Nylatron GS sheave with sealed precision ball bearings. Heavy-duty steel housing clamps to underside of track. Chain bracket for securing offstage curtain edge. Grooved for 1/2" operating line.

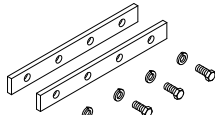

No. 1007 BLACK BAR SPLICE

Steel brackets for aligning "C" channels. With all necessary hardware.

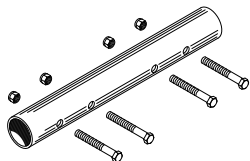

No. 1007P BLACK BATTEN SPLICE

Steel tube splice for backbone. With all necessary hardware.

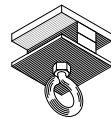

No. 1009 BLACK END STOP & CORD SUPPORT

Steel clamp with eye to support operating line and prevent carriers from traveling beyond desired location. 1 pair required for overlapping tracks.

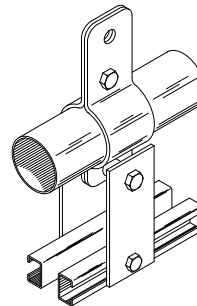

No. 1010 BLACK TRACK

Track is assembled to customer's requirements. Cord operated use only. Track available in 10' and 20' standard lengths.

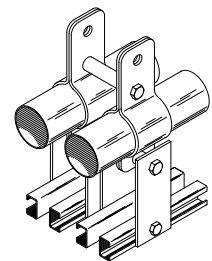

No. 1005 BLACK OVERLAP CLAMP

Tubing spacers mounted between batten clamps to rigidly hold tracks in position at overlap. 1 set required.



BLACK REAR FOLD GUIDE

Allows curtain to fold at offstage edges. Supplied with 1 rubber bumper.

No. 1012 - for 1/2" hand line.

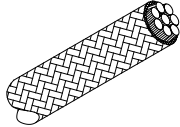
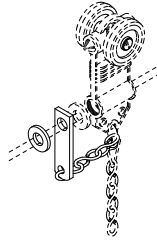

No. 1020 OPERATING LINE

1/2" diameter black spun polyester braided over polyester core for manual operation.

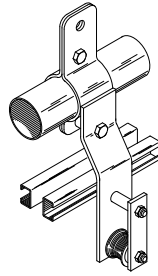

No. 1021 BLACK IDLER PULLEY

Nylatron GS roller with 5/16" shielded ball bearings mounted to steel bracket. Attaches to return side of track to support operating line.

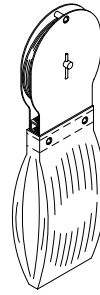

No. 1043 SAND BAG TENSION PULLEY

8" Nylatron GS sheave with precision ball bearings in specially designed housing with heavy-duty sand bag. For maintaining proper operating line tension on flying curtains. Supplied without sand. Grooved for 1/2" operating line.

1018S Black COMPLETE Heavy-Duty Straight Studio Track Standard Items

- 1005 Black Overlap Clamp¹
- 1007 Black Bar Splice²
- 1007P Black Batten Splice²
- 1009 Black End Stop
- 1010B Black Track²
- 1012 Black Rear Fold Guide
- 1018 Black Single Carrier
- 1019 Black Master Carrier
- 1020 Operating Line
- 1021 Black Idler Pulley
- 1023 Black Double End Pulley
- 1024 Black Single End Pulley
- 1043 Sand Bag Tension Pulley

- 1 for bi-parting curtains only.
- 2 track lengths and splices supplied as required from stock sizes.

Model No. 1018S Heavy-Duty Studio Track

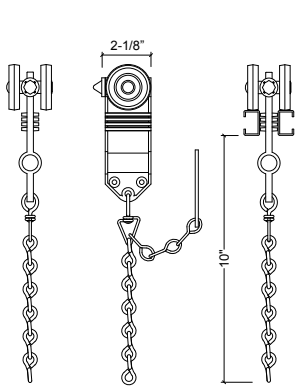

1018 SINGLE CARRIER

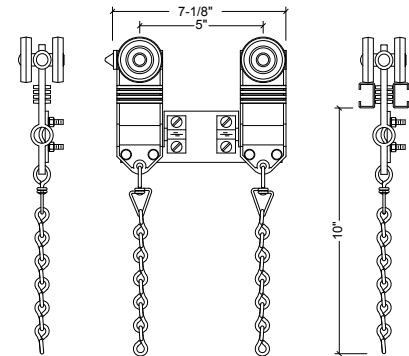
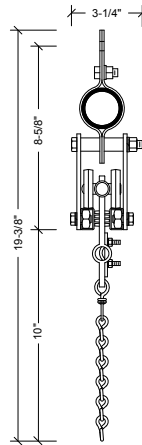

1019 MASTER CARRIER

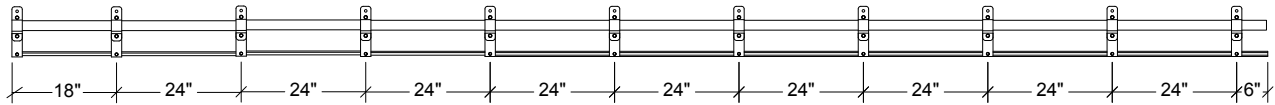

TRACK ASSEMBLY - TYP.

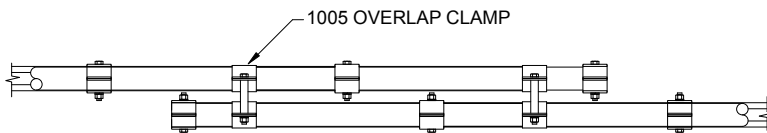

OVERLAP

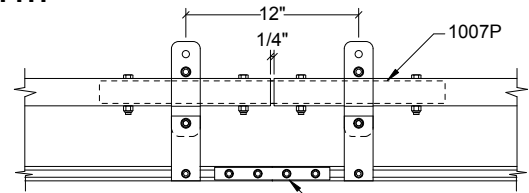

SPLICE

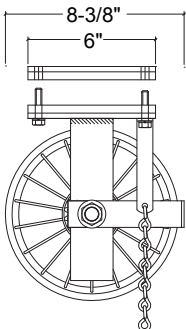

1023 DOUBLE END PULLEY

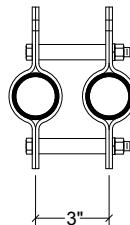
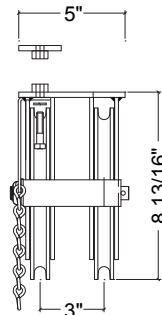

SECTION AT OVERLAP

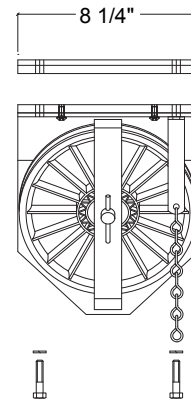

1024 SINGLE END PULLEY

